

Thermo-Kool®

OWNER'S MANUAL

BLAST CHILLERS AND SHOCK FREEZERS

| TK3S-1 | TK3-1 | TK5-1 | TK5-2-C |



THERMO-KOOL/MID-SOUTH INDUSTRIES, INC.

723 East 21st Street, Laurel MS 39440

Phone: (601) 649-4600 Fax: (601) 649-0558

Version: TK002050114

INTRODUCTION

Thank you for purchasing a **Thermo-Kool® Blast Chiller/Shock Freezer**. This unit has been crafted to provide you with exceptional and reliable service for many years.

Your **Thermo-Kool® Blast Chiller/Shock Freezer** has been uniquely designed with the refrigeration system and its controller strategically located for easy operation and maintenance. The cabinet is designed with a back step for better condensing unit ventilation. Another innovative design feature allows the door to be hinged left or right and field reversible. The door also has a seamlessly integrated handle built in and a sanitary magnetic gasket which assures a tight seal and is easily removable for cleaning. All of these unique features were designed with you, the operator, in mind.

All of us on the **Thermo-Kool®** team sincerely appreciate your choosing us, and we are confident that your Blast Chiller/Shock Freezer will exceed your expectations in food preparation and preservation.

This manual will guide you through the operation and programming of the following models: **TK3S-1, TK3-1, TK5-1** and **TK5-2-C**.

Model **TK3S-1** is designed for:

3 - 2/3 Food Pans

2 - 4L Gelato Containers

2 - 5L Gelato Containers

1 - 12L Gelato Container

Model **TK3-1** is designed for:

3 - GN 1/1 food pans

3 - Full Size Food Pans

3 - 4L Gelato Containers

3 - 5L Gelato Containers

1 - 12L Gelato Container

Model **TK5-1** is designed for:

5 - GN 1/1 food pans

4 - Full Size Food Pans

6 - 4L Gelato Containers

6 - 5L Gelato Containers

4 - 12L Gelato Containers

Model **TK5-2-C** is designed for:

5 - GN 1/1 Food Pans

5 - Full Size Food Pans

5 - Sheet Pans 18"X26"

12 - 4L Gelato Containers

12 - 5L Gelato Containers

6 - 12L Gelato Containers

All of these models meet or exceed HACCP, FDA and all state regulations.

IMPORTANT PRODUCT DATA INFORMATION FOR MODEL PURCHASED

For future reference, please record on this page the applicable data found on the unit's data labels. **It is recommended that this page is preserved during the life of the product.**

Reach-ins: Data label is located on the right side of the cabinet in the upper left corner.

Thermo-Kool® Commercial Blast Chiller and/or Shock Freezer

Model No. _____ Serial No. _____ Date Purchased: _____

Refrigerant: 404A Design Pressure: (Low): 174 PSIG (High): 375 PSIG

Charge in oz: _____

Compressor: HP: _____ FLA: _____

Fan: HP: _____ FLA: _____

Volts: _____ PH: _____ Hz: 60 Amps: _____

Min. Circuit Amps: _____ Max. Fuse Size (Amps): _____

TABLE OF CONTENTS:

INSTALLATION REQUIREMENTS.....	1
BLAST CHILLER AND SHOCK FREEZER TECHNOLOGY.....	1
CONTROL PANEL.....	2
OPERATION.....	3
1. AUTOMATIC MODE – SOFT CHILL CYCLE.....	3
2. AUTOMATIC MODE – HARD CHILL CYCLE.....	4
3. AUTOMATIC MODE – SHOCK FREEZE CYCLE.....	5
4. AUTOMATIC MODE – DEFROST CYCLE.....	6
5. MANUAL MODE - SOFT CHILL CYCLE.....	7
6. MANUAL MODE - HARD CHILL CYCLE.....	8
7. MANUAL MODE - SHOCK FREEZE CYCLE.....	9
8. MANUAL MODE - DEFROST CYCLE.....	11
LIST OF COMMANDS.....	13
LOAD STANDARD PARAMETERS.....	14
INITIAL PROGRAMMING.....	14
PROGRAMMING.....	21
TECHNICIAN MENU.....	21
CLEAR EVENTS MEMORY.....	21
PROGRAMMING CYCLES.....	21
1. AUTOMATIC - SOFT CHILL CYCLE PARAMETERS PROGRAMMING.....	22
2. AUTOMATIC - HARD CHILL CYCLE PARAMETERS PROGRAMMING.....	24
3. AUTOMATIC - SHOCK FREEZE CYCLE PARAMETERS PROGRAMMING.....	26
4. AUTOMATIC - DEFROST CYCLE PARAMETERS PROGRAMMING.....	28

5. MANUAL - SOFT CHILL CYCLE PARAMETERS PROGRAMMING.....	29
6. MANUAL - HARD CHILL CYCLE PARAMETERS PROGRAMMING.....	31
7. MANUAL - SHOCK FREEZE CYCLE PARAMETERS PROGRAMMING.....	34
8. MANUAL - DEFROST CYCLE PARAMETERS PROGRAMMING.....	35
ELECTRICAL DIAGRAM.....	38
PRINTER (OPTIONAL).....	39
PC CONNECTION (OPTIONAL).....	40
CLEANING INSTRUCTIONS.....	41
TROUBLESHOOTING GUIDE FOR TK3S-1, TK3-1 AND TK5-1.....	42
TROUBLESHOOTING GUIDE FOR TK5-2-C.....	44
WARRANTY.....	46

INSTALLATION REQUIREMENTS

These models have an electrical cord and plug as standard.

Models TK3S-1, TK3-1 and TK5-1 have three-inch casters (two with brakes) as standard. For these units, the rolling surface should be properly leveled and casters locked. Model TK5-2-C has adjustable stainless steel legs.

A minimum of four inches is recommended for proper clearance around the unit.

BLAST CHILLER AND SHOCK FREEZER TECHNOLOGY

These appliances rapidly reduce the core temperature of raw or cooked foods to safe cold storage temperature levels.

Blast chilling must attain within two hours a product core temperature of 37 °F - 40 °F and shock freezing must reach a product core temperature of 0 °F within four hours.

The interval between 140 °F and 40 °F, commonly referred to as the “Danger Zone,” is considered the ideal temperature range for bacteria proliferation in most food products.

The methods of blast chilling and shock freezing help avoid food deterioration by retarding or even stopping bacteria proliferation.

After blast chilling, the food can be preserved at temperatures of 37 °F - 40 °F for as long as five days before it is served. Shock freezing will allow food to be safely preserved in a frozen state for several months.

CONTROL PANEL

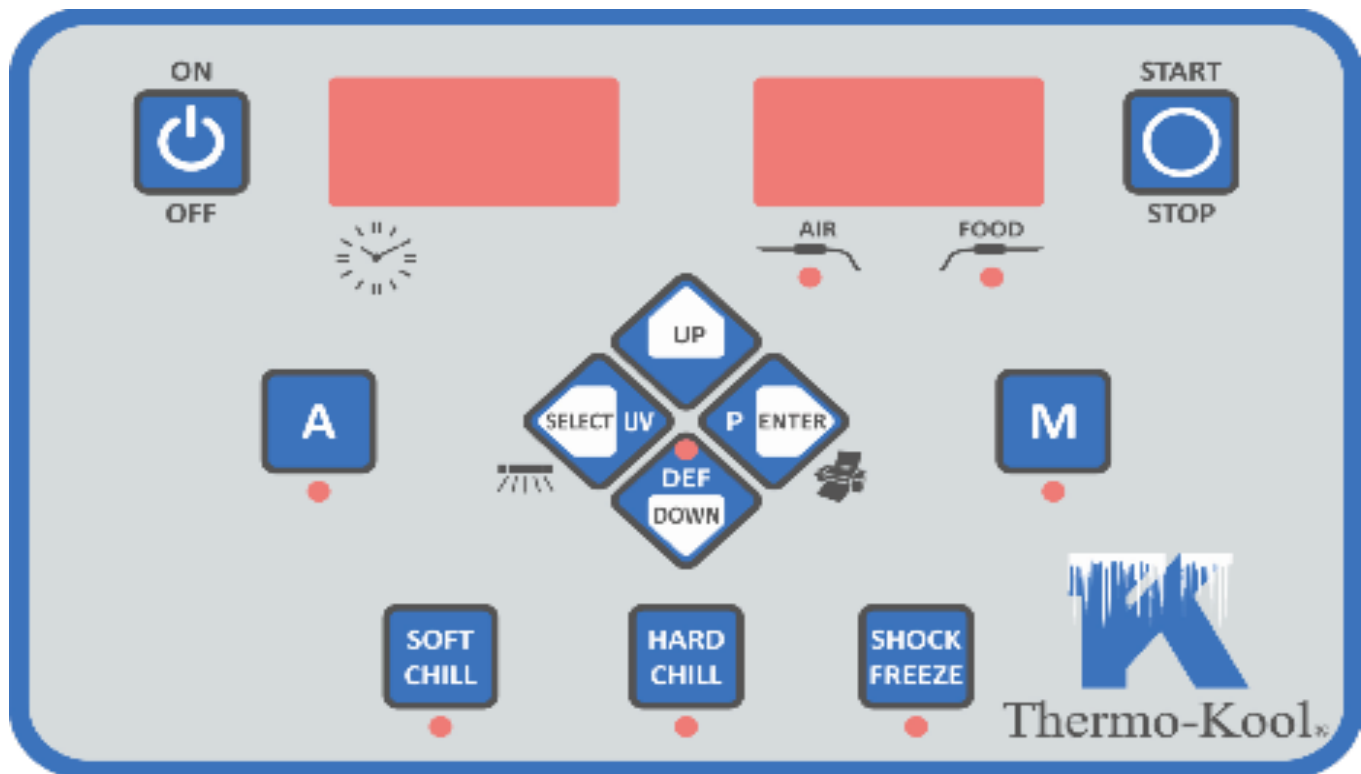

Please read the manual before operating this unit!

OPERATION

From "OFF" displayed press  (ON/OFF button)

Select mode: press "A" (automatic) or "M" (manual)

Select cycle: press "SOFT" or "HARD" or "SHOCK"

Press "ENTER"

Press "START/STOP"

PROGRAMMING

From "OFF" displayed press & hold "START/STOP"

The displays will show: "P- - - -"

Input the password and press "ENTER"

PROGRAMMING CYCLES

From "OFF" displayed press & hold "SELECT"

The displays will show: "PC- - - -"



Enter the password and press "ENTER"





OPERATION

With the display reading **OFF**, press  (ON/OFF).

The display will show:



 (Automatic) and  (Manual) will begin flashing, indicating for one mode or the other to be selected.

When the **AUTOMATIC** or **MANUAL** mode has been selected, , ,  and  will begin flashing, indicating for one of the cycles to be selected.

*****Important! The AUTOMATIC MODES use both the air and food temperatures to control the cycles.*****

1. AUTOMATIC MODE – SOFT CHILL CYCLE

Note: The food probe must be used with this cycle!

With the display reading **OFF**, press  (ON/OFF), then press  and then .

The display will show:



Press  (START/STOP) to start the cycle.

The left-hand display will show the cycle time which counts up in minutes. The right-hand display will alternate showing the air and food temperatures.

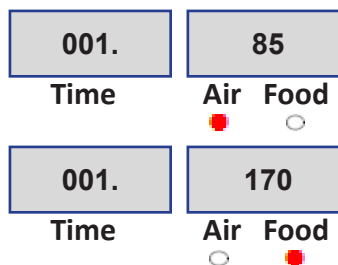

When the food temperature has reached the **TARGET FOOD TEMPERATURE** set in **PROGRAMMING CYCLES** (default 40 °F), a beep will sound for ten seconds. The unit will automatically switch to holding mode. The display will alternate showing the air and food temperatures.

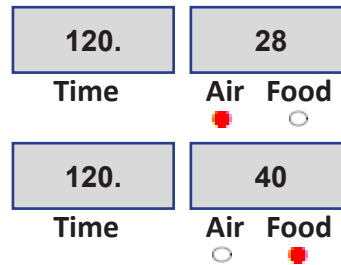

The unit will remain in holding mode, monitoring the air and food temperatures until the cycle is stopped by pressing



(START/STOP).

Once the cycle has been stopped, the display will show:



and will begin flashing, signifying another cycle may be selected if desired.

If no cycle is selected after one minute, the display will show:



2. AUTOMATIC MODE – HARD CHILL CYCLE

Note: The food probe must be used with this cycle!

With the display reading **OFF**, press  (ON/OFF), then press  and then .

The display will show:



Press  (START/STOP) to start the cycle.

The left-hand display will show the cycle time which counts up in minutes. The right-hand display will alternate showing the air and food temperatures.

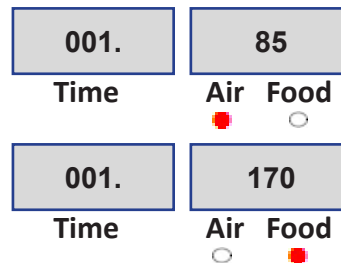

When the food temperature has reached the **TARGET FOOD TEMPERATURE** set in **PROGRAMMING CYCLES** (default 40 °F), a beep will sound for ten seconds. The unit will automatically switch to holding mode. The display will alternate showing the air and food temperatures.

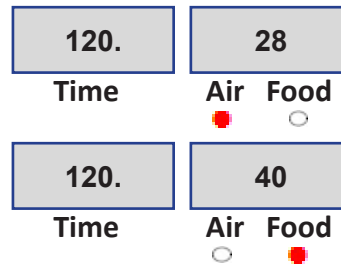

The unit will remain in holding mode, monitoring the air and food temperatures until the cycle is stopped by pressing



(START/STOP).

Once the cycle has been stopped, the display will show:



and will begin flashing, signifying another cycle may be selected if desired.

If no cycle is selected after one minute, the display will show:



3. AUTOMATIC MODE – SHOCK FREEZE CYCLE

Note: The food probe must be used with this cycle!

With the display reading **OFF**, press  (ON/OFF), then press  and then .

The display will show:



Press  (START/STOP) to start the cycle.

The left-hand display will show the cycle time which counts up in minutes. The right-hand display will alternate showing the air and food temperatures.

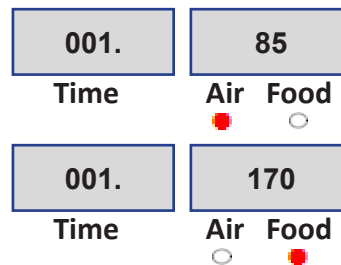

When the food temperature has reached the **TARGET FOOD TEMPERATURE** set in **PROGRAMMING CYCLES** (default 0 °F), a beep will sound for ten seconds. The unit will automatically switch to holding mode. The display will alternate showing the air and food temperatures.

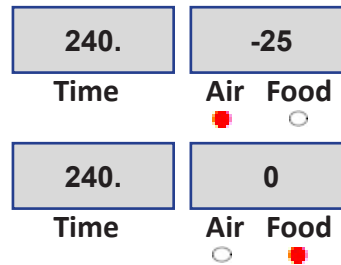

The unit will remain in holding mode, monitoring the air and food temperatures until the cycle is stopped by pressing



(START/STOP).

Once the cycle has been stopped, the display will show:



and will begin flashing, signifying another cycle may be selected if desired.

If no cycle is selected after one minute, the display will show:



*****In order to use the AUTOMATIC DEFROST CYCLE, Automatic Defrost Availability must be set to 1 for YES in Defrost Cycle Parameters Programming (See page 28 for instructions).*****

4. AUTOMATIC MODE – DEFROST CYCLE

The display will show:



Once the unit has operated for the minimum accumulated run time set in **PROGRAMMING CYCLES** (default six hours) the **DEFROST CYCLE** will automatically begin and the left-hand display will show the duration of the cycle in minutes as set in **PROGRAMMING CYCLES** (default 40 minutes):



When the cycle is complete, the display will show:



(Flashing)

To stop the cycle press  (START/STOP).

NOTE: During defrost, the compressor is **OFF** and the fan evaporator is **ON**.
The cycle will run with the door open (recommended) or closed.

*****Important! The MANUAL MODES use ONLY time and air probe temperatures to control the cycles.*****





5. MANUAL MODE - SOFT CHILL CYCLE

With the display reading **OFF**, press  (ON/OFF), then press  and then .

The left-hand display will show the **CYCLE TIME** in minutes as set in **PROGRAMMING CYCLES** (default 120 minutes):



(Flashing)

To change the **CYCLE TIME**, press  or  then press , or press  to accept the default cycle time.



The display will show:

Press  (START/STOP) to start the cycle.

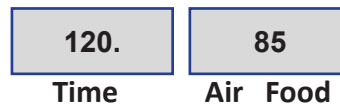

The left-hand display will show the cycle time which counts down in minutes. The right-hand display will alternate showing the air and food temperatures.

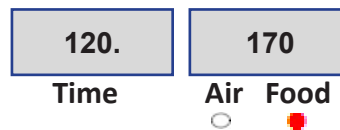

When the set cycle time is reached, a beep will sound for ten seconds and the unit will automatically switch to holding mode. The display will alternate showing the air and food temperatures.

The unit will remain in holding mode, monitoring the air and food temperatures until the cycle is stopped by pressing



(START/STOP).

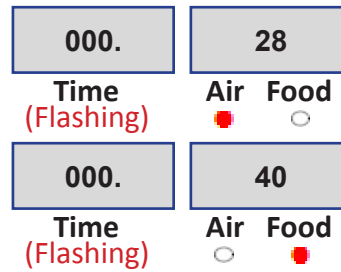

Once the cycle has been stopped, the display will show:



and



will begin flashing, signifying another cycle may be selected if desired.

If no cycle is selected after one minute, the display will show:



6. MANUAL MODE - HARD CHILL CYCLE

With the display reading **OFF**, press (ON/OFF), then press and then .

The left-hand display will show the **TOTAL CYCLE TIME** in minutes as set in **PROGRAMMING CYCLES** (default 120 minutes):

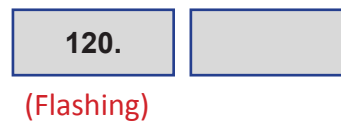

To change the **TOTAL CYCLE TIME**, press



or



then press



, or

press to accept the default cycle time.



The display will show:

Press  (START/STOP) to start the cycle.

The left-hand display will show the cycle time which counts down in minutes. The right-hand display will alternate showing the air and food temperatures.

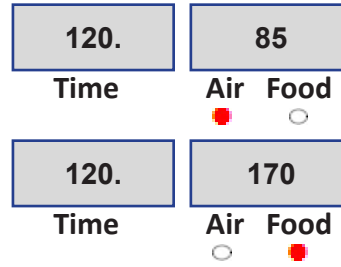



When the set cycle time is reached, a beep will sound for ten seconds and the unit will automatically switch to holding mode. The display will alternate showing the air and food temperatures.

The unit will remain in holding mode, monitoring the air and food temperatures until the cycle is stopped by pressing

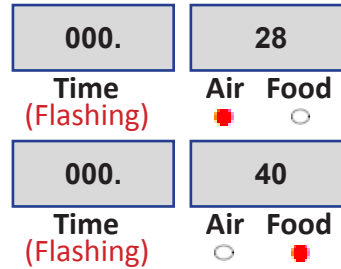
 (START/STOP).



Once the cycle has been stopped, the display will show:

 **A** and  **M** will begin flashing, signifying another cycle may be selected if desired.

If no cycle is selected after one minute, the display will show:

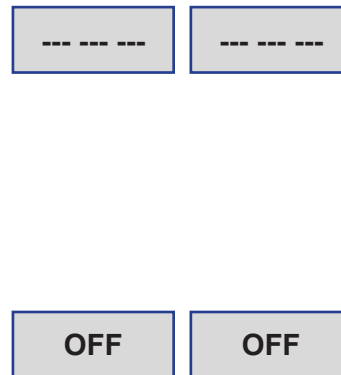



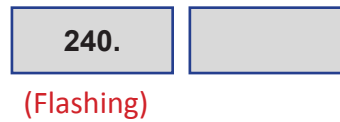

7. MANUAL MODE - SHOCK FREEZE CYCLE

With the display reading **OFF**, press  (ON/OFF), then press  and then .

The left-hand display will show the **CYCLE TIME** in minutes as set in **PROGRAMMING CYCLES** (default 240 minutes):



To change the **CYCLE TIME**, press  or  then press , or  to accept the default cycle time.



The display will show:

Press  (START/STOP) to start the cycle.

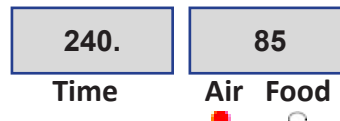

The left-hand display will show the cycle time which counts down in minutes. The right-hand display will alternate showing the air and food temperatures.

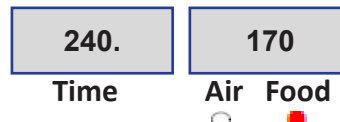

When the set cycle time is reached, a beep will sound for ten seconds and the unit will automatically switch to holding mode. The display will alternate showing the air and food temperatures.



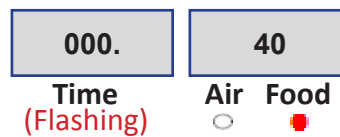

The unit will remain in holding mode, monitoring the air and food temperatures until the cycle is stopped by pressing

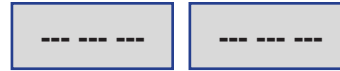

 (START/STOP).

Once the cycle has been stopped, the display will show:



 and  will begin flashing, signifying another cycle may be selected if desired.

If no cycle is selected after one minute, the display will show:



8. MANUAL MODE - DEFROST CYCLE

With the display reading **OFF**, press  (ON/OFF), then press  and then .

The display will show:



To start the cycle, press  (START/STOP).

The left-hand display will show **DEFROST TIME** in minutes as set in the **PROGRAMMING CYCLES** (default 15 minutes).



When the cycle is complete, the display will show:



(Flashing)



To stop the cycle before it is complete, press

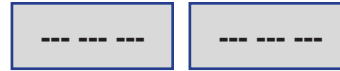

(START/STOP) two times.

Once the cycle has been stopped, the display will show:



 and  will begin flashing, signifying another cycle may be selected if desired.

If no cycle is selected after one minute, the display will show:



To stop any cycle before it is complete

Press the  (START/STOP) two times.



The controller will beep.

The display will show:



Once the cycle has been stopped, the display will show:



 and  will begin flashing, signifying another cycle may be selected if desired.

If no cycle is selected after one minute, the display will show:



LIST OF COMMANDS



With the display reading **OFF** press and hold  . This command will give you access to:

- **LOAD STANDARD PARAMETERS:** This will allow the operator to reset the unit to its original settings and most importantly to its original password.
-



With the display reading **OFF** press and hold  (START/STOP). This command will give you access to:

- **INITIAL PROGRAMMING:** The default parameters in initial programming are preset at the factory but may also be accessed by the operator for changes in order to meet the operator's specific needs.
-



With the display reading **OFF** press and hold  . This command will give you access to:

- **PROGRAMMING CYCLES:** The default parameters in programming cycles are preset at the factory but may also be accessed by the operator for changes in order to meet the operator's specific needs.
-



With the display reading **OFF** press and hold  . This command will give you access to:

- **CLEAR EVENTS MEMORY:** This will clear the controller memory of all data collected during a cycle event(s).
-



With the display reading **OFF** press and hold  ,  and  . This command will give you access to:

- **TECHNICIAN MENU:** The default parameters in the technician menu are preset at the factory and are recommended to be accessed only by a qualified service technician.
-



With the display reading **OFF** press  (ON/OFF). This command will give you access to the various **OPERATIONAL CYCLES**.

LOAD STANDARD PARAMETERS

This command will allow the operator to reset the unit to its original settings and most importantly to its original password.

With the display reading **OFF**, press and hold



for ten seconds. The display will show:



The default setting for the **LOAD STANDARD PARAMETERS** is **1** for **YES**.

To change to **0** for **NO**,



or



then press



.



The display will then show:



INITIAL PROGRAMMING

The default parameters in **INITIAL PROGRAMMING** are preset at the factory. If no changes are desired please turn to page 3 for **OPERATION** instructions.

In order to access the programming features of this controller, the display must be in the **OFF** mode.

During programming,  can be used to return to the previous screen, and  is used to confirm the settings and advance to the next screen.

With the display reading **OFF**, press and hold



(START/STOP) until a beep sounds and the display shows:



Enter the default password by pressing (in

order)   and 

then press .



The display will show:



n PS 0

If you do not wish to change the password,

New password (Flashing)

press .

To change the password, press  or

 for 1 for YES then press .

The password can be a three key combination of any:

, , ,  and .

Enter the new password and

press .

n PS 0

New password

Re-enter the password and

press .

r PS 0

Re-enter password

The display will show:

Cod OH

Code OK

NOTE: It is advised that a record of the password be kept in a safe place.

If an incorrect password is entered, the display will show:

Cd E rr

Code Error

Enter the correct password and press .

"1." indicates the last two digits of the YEAR.

To change the YEAR,

press  or  then press .

1. 12

(Flashing)

"2." indicates the MONTH of the year.

To change the MONTH,

press  or  then press .

2. 01

(Flashing)

“3.” indicates the **DAY** of the month.

To change the **DAY**,



press  or  then press  .

3.

16

(Flashing)

“4.” indicates the **TIME**.

To set the **HOUR**, press  or 
(continue to press until the hour and
AM or **PM** show correctly-**PM** is indicated by
a period at the end of the minutes display)

then press  or press  to set the
minutes.

4. 03

45.

(Flashing)

To set the **MINUTES**,

press  or  then press  .

4. 03

45.

(Flashing)

“5.” indicates the **TEMPERATURE SCALE**.

The default setting for the **TEMPERATURE SCALE** temperature is °F.

To change to °C,

press  or  then press  .

5.

°F

(Flashing)

“6.” indicates the number of **FOOD PROBES**.

The default setting for the number of **FOOD PROBES** is one.

Press  to accept this default setting.

6.

1

(Flashing)

“7.” indicates the **HIGH AIR ALARM TEMPERATURE**.

The default setting for the **HIGH AIR ALARM TEMPERATURE** is **140 °F**.

To change the temperature,

press  or  then press  .

7.

140

(Flashing)

This is the temperature at which an alarm will sound if the air cavity temperature rises above its setting.

"8." indicates the **LOW AIR ALARM TEMPERATURE**.

8.

-35

(Flashing)

The default setting for the **LOW AIR ALARM TEMPERATURE** is **-35 °F**.

This is the temperature at which an alarm will sound if the air cavity temperature falls below its setting.

To change the temperature,

press  or  then press  .

"9." indicates the **HIGH FOOD ALARM TEMPERATURE**.

9.

180

(Flashing)

The default setting for the **HIGH FOOD ALARM TEMPERATURE** is **180 °F**.

This is the temperature at which an alarm will sound if the food temperature, as measured by the food probe, rises above its setting.

To change the temperature,

press  or  then press  .

"10." indicates the **LOW FOOD ALARM TEMPERATURE**.

10.

35

(Flashing)

The default setting for the **LOW FOOD ALARM TEMPERATURE** is **35 °F**.

This is the temperature at which an alarm will sound if the food temperature, as measured by the food probe, falls below its setting.

To change the temperature,

press  or  then press  .

"11." indicates **SHOCK FREEZE**.

11.

1

(Flashing)

The default setting for the **SHOCK FREEZE** is **1** for **YES**.

This setting indicates if the unit has shock freeze capabilities.

To change to **0** for **NO**,

press  or  then press  .

"12." indicates **GELATO**.

12.

0

(Flashing)

The default setting for **GELATO** is **0** for **NO**.

This function will allow the unit to continue operating if the door is opened during a freeze cycle.

To change to **1** for **YES**,

press  or  then press  .

“13.” indicates **UV**, or **ULTRAVIOLET**.

The default setting for **UV** is **0** for **NO**.

If your unit has **UV** capability and this option was purchased,

press  or  to change to **1** for **YES**.

13.

0

(Flashing)



UV aids in the sanitization of the interior of the unit.

NOTE: If **0** for **NO** was selected for “13.”, the display will move to “15.” If **1** for **YES** was selected, the display will continue to “14.”

“14.” indicates **UV TIME**.

The default setting for **UV TIME** is **30 minutes**.

To increase this time

press  or to decrease press ,
then press .

14.

30

(Flashing)

“15.” indicates **PC**.

The default setting for **PC** is **0** for **NO**.

To change to **1** for **YES**,

press  or  then press .

15.

0

(Flashing)

This setting indicates if the optional PC connection was purchased and installed.

NOTE: If **0** for **NO** was selected for “15.”, the display will move to “18.” If **1** for **YES** was selected, the display will continue to “16.”

“16.” indicates the **PC BAUD RATE**.

The default setting for the **PC BAUD RATE** is **38400**.

To change the rate,

press  or  then press .

38

400

(Flashing)

(Flashing)

“17.” indicates the **NETWORK ID**.

The default setting for the **NETWORK ID** is **01**.

To change the number from **01** to **32**,

press  or  then press .

17.

01

(Flashing)

This is the unique ID for the unit when multiple units are connected using the optional PC connection.

“18.” indicates **PRINTER**.

The default setting for **PRINTER** is **0** for **NO**.

To change to **1** for **YES**,

press  or  then press .

18.

0

(Flashing)

This setting indicates if an optional printer was purchased and installed.

NOTE: If **0** for **NO** was selected for “18,” the display turn off. If **1** for **YES** was selected, the display will continue to “19.”

“19.” indicates the **PRINTER TYPE**.

The default setting for the **PRINTER TYPE** is **STANDARD (S)**.

To change the type to **LABEL (L)**,

press  or  then press .

19.

S

(Flashing)

“20.” indicates the **PRINTER BAUD RATE**.

The default setting for the **PRINTER BAUD RATE** is **9600**.

To change the rate,

press  or  then press .

20. 9

600

(Flashing)

“21.” indicates **PRINTER TIMING**.

The default setting for **PRINTER TIMING** is **15 minutes**.

To change the time,

press  or  then press .

21.

15

(Flashing)

This refers to the time interval in which the controller records HACCP data during a cycle.

“22.” indicates **PRINT DURING CYCLE**.

The default setting for **PRINT DURING CYCLE** is **0** for **NO**.

22. 0

(Flashing)

To change to **1** for **YES**,

press  or  then press  .

This setting determines if the recorded HACCP data is printed during a cycle.

After the last entry, the display will return to the **OFF** position.

NOTE: To end **INITIAL PROGRAMMING** and save any changes that have been made, press  (ON/OFF) at any time.

PROGRAMMING

TECHNICIAN MENU

The parameters in this menu are preset at the factory and recommended to be accessed only by a qualified service technician.

CLEAR EVENTS MEMORY

This command will clear the controller memory of all data recorded during cycle events.

To make the selection press and hold



CLr

--- ---

Enter the default password by pressing the following sequence:



and



CLr

0 0 0

OR

Enter the new password created during **INITIAL PROGRAMMING**.

To change **1** for **YES** or **0** for **NO**,



or



then press



CLr

1

If **1** is selected, then the cycle will clear the memory and the display will change to the **OFF** position.

OFF

OFF

PROGRAMMING CYCLES

The default parameters in Programming Cycles are preset at the factory, but may also be accessed by the operator for changes in order to meet the operator's specific needs.

With the display reading **OFF**, press and hold



until the display shows:

P C -



--- ---

Enter the password and press .

P C - **0 0 0**

Once the password is entered, the display will show:

P C - **--- --- ---**

 and  will begin flashing, signifying for a programming cycle to be selected.

1. AUTOMATIC - SOFT CHILL CYCLE PARAMETERS PROGRAMMING

***Note:** If the unit is **OFF**, first follow the initial start-up instructions at the beginning of the **PROGRAMMING CYCLES** section on page 21.*

To access the **AUTOMATIC SOFT CHILL** cycle, press  then .

“1.” indicates the **LOW AIR TEMPERATURE**.

1. **28**

The default setting for the **LOW AIR TEMPERATURE** is **28 °F**.

(Flashing)

To change the temperature,

press  or  then press .

This is the minimum air cavity temperature at which the unit operates during the chilling process.

NOTE: There should always be a minimum of seven degrees difference between the low and high air temperature settings.

“2.” indicates the **HIGH AIR TEMPERATURE**.

2. **35**

The default setting for the **HIGH AIR TEMPERATURE** is **35 °F**.

(Flashing)

To change the temperature,

press  or  then press .

This is the maximum air cavity temperature at which the unit operates during the chilling process.

"3." indicates the **TARGET FOOD TEMPERATURE**.

The default setting for the **TARGET FOOD TEMPERATURE** is **40 °F**.

To change the temperature,

press  or  then press .

3. **40**

(Flashing)

This is the desired food temperature, as measured by the food probe, at which the unit automatically ends the chilling process and transitions into holding mode.

"4." indicates the **HOLD LOW AIR TEMPERATURE**.

The default setting for the **HOLD LOW AIR TEMPERATURE** is **35 °F**.

To change the temperature,

press  or  then press .

4. **35**

(Flashing)

This is the minimum air cavity temperature at which the unit operates during holding mode.

NOTE: There should always be a minimum of seven degrees difference between the hold low and hold high air temperature settings.

"5." indicates the **HOLD HIGH AIR TEMPERATURE**.

The default setting for the **HOLD HIGH AIR TEMPERATURE** is **42 °F**.

To change the temperature,

press  or  then press .

5. **42**

(Flashing)

This is the maximum air cavity temperature at which the unit operates during holding mode.

The display will show:

P C - **-----**

Another cycle may be selected to program at

this time, or press  (ON/OFF) to end the **PROGRAMMING CYCLES**.

If no action is taken after one minute, the unit will return to the **OFF** position and the display will show:

OFF **OFF**

2. AUTOMATIC - HARD CHILL CYCLE PARAMETERS PROGRAMMING

Note: If the unit is **OFF**, first follow the initial start-up instructions at the beginning of the **PROGRAMMING CYCLES** section on page 21.

To access the **AUTOMATIC HARD CHILL** cycle, press  then .

“1.” indicates the **LOW AIR TEMPERATURE** for **Zone 1**.

The default setting for the **LOW AIR TEMPERATURE** for **Zone 1** is **0 °F**.

To change the temperature,

press  or  then press .

(Flashing)

This is the minimum air cavity temperature at which the unit operates during Zone 1 of the chilling process.

NOTE: There should always be a minimum of seven degrees difference between the low and high air temperature settings.

“2.” indicates the **HIGH AIR TEMPERATURE** for **Zone 1**.

The default setting for the **HIGH AIR TEMPERATURE** for **Zone 1** is **10 °F**.

To change the temperature,

press  or  then press .

(Flashing)

This is the maximum air cavity temperature at which the unit operates during Zone 1 of the chilling process.

“3.” indicates the **BREAK FOOD TEMPERATURE**.

The default setting for the **BREAK FOOD TEMPERATURE** is **60 °F**.

To change the temperature,

press  or  then press .

(Flashing)

This is the temperature of the food, as measured by the food probe, at which the unit transitions from Zone 1 to Zone 2.

"4." indicates the **LOW AIR TEMPERATURE** for **Zone 2**.

The default setting for the **LOW AIR TEMPERATURE** for **Zone 2** is **28 °F**.

To change the temperature,

press  or  then press .

4.

28

(Flashing)

This is the minimum air cavity temperature at which the unit operates during Zone 2 of the chilling process.

NOTE: There should always be a minimum of seven degrees difference between the low and high air temperature settings.

"5." indicates the **HIGH AIR TEMPERATURE** for **Zone 2**.

The default setting for the **HIGH AIR TEMPERATURE** for **ZONE 2** is **35 °F**.

To change the temperature,

press  or  then press .

5.

35

(Flashing)

This is the maximum air cavity temperature at which the unit operates during Zone 2 of the chilling process.

"6." indicates the **TARGET FOOD TEMPERATURE**.

The default setting for the **TARGET FOOD TEMPERATURE** is **40 °F**.

To change the temperature,

press  or  then press .

6.

40

(Flashing)

This is the desired food temperature, as measured by the food probe, at which the unit automatically ends the chilling process and transitions into the holding mode.

"7." indicates the **HOLD LOW AIR TEMPERATURE**.

The default setting for the **HOLD LOW AIR TEMPERATURE** is **35 °F**.

To change the temperature,

press  or  then press .

7.

35

(Flashing)

This is the minimum air cavity temperature at which the unit operates during holding mode.

NOTE: There should always be a minimum of seven degrees difference between the hold low and hold high air temperature settings.

“8.” indicates the **HOLD HIGH AIR TEMPERATURE**.

8. 42

(Flashing)

This is the maximum air cavity temperature at which the unit operates during holding mode.

The default setting for the **HOLD HIGH AIR TEMPERATURE** is **42 °F**.

To change the temperature,

press  or  then press .

The display will show:

P C - --- -- --

Another cycle may be selected to program

at this time, or press  (ON/OFF) to end the **PROGRAMMING CYCLES**.

If no action is taken after one minute, the unit will return to the **OFF** position and the display will show:

OFF OFF

3. AUTOMATIC - SHOCK FREEZE CYCLE PARAMETERS PROGRAMMING

Note: If the unit is **OFF**, first follow the initial start-up instructions at the beginning of the **PROGRAMMING CYCLES** section on page 21.

To access the **AUTOMATIC SHOCK FREEZE** cycle, press  then .

If **SHOCK FREEZE** was set to **0** for **NO** in **INITIAL PROGRAMMING**, the display will show:

n .A

(not available)

“1.” indicates the **LOW AIR TEMPERATURE**.

1. -25

(Flashing)

This is the minimum air cavity temperature at which the unit operates during the freezing process.

The default setting for the **LOW AIR TEMPERATURE** is **-25 °F**.

To change the temperature,

press  or  then press .

NOTE: There should always be a minimum of seven degrees difference between the low and high air temperature settings.

"2." indicates the **HIGH AIR TEMPERATURE**.

The default setting for the **HIGH AIR TEMPERATURE** is **-15 °F**.

To change the temperature,

press  or  then press .

2.

-15

(Flashing)

This is the maximum air cavity temperature at which the unit operates during the freezing process.

"3." indicates the **TARGET FOOD TEMPERATURE**.

The default setting for the **TARGET FOOD TEMPERATURE** is **0 °F**.

To change the temperature,

press  or  then press .

3.

0

(Flashing)

This is the desired food temperature, as measured by the food probe, at which the unit automatically ends the freezing process and transitions into holding mode.

"4." indicates the **HOLD LOW AIR TEMPERATURE**.

The default setting for the **HOLD LOW AIR TEMPERATURE** is **-4 °F**.

To change the temperature,

press  or  then press .

4.

-4

(Flashing)

This is the minimum air cavity temperature at which the unit operates during holding mode.

NOTE: There should always be a minimum of seven degrees difference between the hold low and hold high air temperature settings.

"5." indicates the **HOLD HIGH AIR TEMPERATURE**.

The default setting for the **HOLD HIGH AIR TEMPERATURE** is **3 °F**.

To change the temperature,

press  or  then press .

5.

3

(Flashing)

This is the maximum air cavity temperature at which the unit operates during holding mode.

The display will show:



Another cycle may be selected to program

at this time, or press  (ON/OFF) to end the **PROGRAMMING CYCLES**.

If not action is taken after one minute, the unit will return to the **OFF** position and the display will show:



4. AUTOMATIC - DEFROST CYCLE PARAMETERS PROGRAMMING

*Note: If the unit is **OFF**, first follow the initial start-up instructions at the beginning of the **PROGRAMMING CYCLES** section on page 21.*

To access the **DEFROST CYCLE** cycle, press  then .

"1." indicates the **DEFROST TIME** if Manual Start is used.



The default setting for the **DEFROST TIME** is **15 minutes**.

(Flashing)

To change the time,

press  or  then press .

"2." indicates the **AUTOMATIC DEFROST AVAILABILITY**.



The default setting for the **AUTOMATIC DEFROST AVAILABILITY** is **0** for **NO**.

(Flashing)

To change to **1** for **YES**,

press  or  then press .

If **1** is selected then:

“**3.**” indicates the **MINIMUM ACCUMULATED RUN TIME** the unit must operate before the **AUTOMATIC DEFROST** cycle will start.

3.

H 06

(Flashing)

The default setting for the **MINIMUM ACCUMULATED RUN TIME** is **SIX HOURS (H 06)**.

To change the time,



press  or  then press .

“**4.**” indicates the **DURATION** of the automatic defrost cycle.

4.

40

(Flashing)

The default setting for the **DURATION** is **40 minutes**.

To change the time,



press  or  then press .

The display will show:

P C -

Another cycle may be selected to program

at this time, or press  (ON/OFF) to end the **PROGRAMMING CYCLES**.

If no action is taken after one minute, the unit will return to the **OFF** position and the display will show:

OFF

OFF

5. MANUAL - SOFT CHILL CYCLE PARAMETERS PROGRAMMING

Note: If the unit is **OFF**, first follow the initial start-up instructions at the beginning of the **PROGRAMMING CYCLES** section on page 21.

To access the **MANUAL SOFT** cycle, press  then .

“1.” indicates the **LOW AIR TEMPERATURE**.

The default setting for the **LOW AIR TEMPERATURE** is **28 °F**.

To change the temperature,

press  or  then press  .

1.

28

(Flashing)

This is the minimum air cavity temperature at which the unit operates during the chilling process.

NOTE: There should always be a minimum of seven degrees difference between the low and high air temperature settings.

“2.” indicates the **HIGH AIR TEMPERATURE**.

The default setting for the **HIGH AIR TEMPERATURE** is **35 °F**.

To change the temperature,

press  or  then press  .

2.

35

(Flashing)

This is the maximum air cavity temperature at which the unit operates during the chilling process.

“3.” indicates the **CYCLE TIME**.

The default setting for the **CYCLE TIME** is **120 minutes**.

To change the time,

press  or  then press  .

3.

120

(Flashing)

“4.” indicates the **HOLD LOW AIR TEMPERATURE**.

The default setting for the **HOLD LOW AIR TEMPERATURE** is **35 °F**.

To change the temperature,

press  or  then press  .

4.

35

(Flashing)

This is the minimum air cavity temperature at which the unit operates during holding mode.

NOTE: There should always be a minimum of seven degrees difference between the hold low and hold high air temperature settings.

"5." indicates the **HOLD HIGH AIR TEMPERATURE**.

The default setting for the **HOLD HIGH AIR TEMPERATURE** is **42 °F**.

To change the temperature,

press  or  then press .

4. 42

(Flashing)

This is the maximum air cavity temperature at which the unit operates during holding mode.

The display will show:

P C - - - - -

Another cycle maybe selected to program

at this time, or press  (ON/OFF) to end the **PROGRAMMING CYCLES**.

If no action is taken after one minute, the unit will return to the **OFF** position and the display will show:

OFF OFF

6. MANUAL - HARD CHILL CYCLE PARAMETERS PROGRAMMING

Note: If the unit is **OFF**, first follow the initial start-up instructions at the beginning of the **PROGRAMMING CYCLES** section on page 21.

To access the **MANUAL HARD CHILL** cycle, press  then .

"1." indicates the **LOW AIR TEMPERATURE** for **Zone 1**.

The default setting for the **LOW AIR TEMPERATURE** for **Zone 1** is **0 °F**.

To change the temperature,

press  or  then press .

1. 0

(Flashing)

This is the minimum air cavity temperature at which the unit operates during Zone 1 of the chilling process.

NOTE: There should always be a minimum of seven degrees difference between the low and high air temperature settings.

"2." indicates the **HIGH AIR TEMPERATURE** for **Zone 1**.

The default setting for the **HIGH AIR TEMPERATURE** for **Zone 1** is **10 °F**.

To change the temperature,

press  or  then press  .

2.

10

(Flashing)

This is the maximum air cavity temperature at which the unit operates during Zone 1 of the chilling process.

"3." indicates the **LOW AIR TEMPERATURE** for **Zone 2**.

The default setting for the **LOW AIR TEMPERATURE** for **Zone 2** is **28 °F**.

To change the temperature,

press  or  then press  .

3.

28

(Flashing)

This is the minimum air cavity temperature at which the unit operates during Zone 2 of the chilling process.

NOTE: There should always be a minimum of seven degrees difference between the low and high air temperature settings.

"4." indicates the **HIGH AIR TEMPERATURE** for **Zone 2**.

The default setting for the **HIGH AIR TEMPERATURE** for **Zone 2** is **35 °F**.

To change the temperature,

press  or  then press  .

4.

35

(Flashing)

This is the maximum air cavity temperature at which the unit operates during Zone 2 of the chilling process.

"5." indicates the **TOTAL CYCLE TIME**.

The default setting for the **TOTAL CYCLE TIME** is **120 minutes**.

To change the time,

press  or  then press  .

5.

120

(Flashing)

"6." indicates the **PERCENTAGE OF TOTAL CYCLE TIME** for **Zone 1**.

6. 75

(Flashing)

The default setting for the **PERCENTAGE OF TOTAL CYCLE TIME** for **Zone 1** is **75%**.

This setting indicates the percentage of the total cycle time the unit will operate in Zone 1 before transitioning to Zone 2.

To change the percentage,

press  or  then press .

"7." indicates the **HOLD LOW AIR TEMPERATURE**.

7. 35

(Flashing)

The default setting for the **HOLD LOW AIR TEMPERATURE** is **35 °F**.

This is the minimum air cavity temperature at which the unit operates during holding mode.

To change the temperature,

press  or  then press .

NOTE: There should always be a minimum of seven degrees difference between the hold low and hold high air temperature settings.

"8." indicates the **HOLD HIGH AIR TEMPERATURE**.

8. 42

(Flashing)

The default setting for the **HOLD HIGH AIR TEMPERATURE** is **42 °F**.

This is the maximum air cavity temperature at which the unit operates during holding mode.

To change the temperature,

press  or  then press .

The display will show:

P C - --- -- --

Another cycle may be selected to program

at this time, or press  (ON/OFF) to end the **PROGRAMMING CYCLES**.

If no action is taken after one minute, the unit will return to the **OFF** position and the display will show:

OFF OFF

7. MANUAL - SHOCK FREEZE CYCLE PARAMETERS PROGRAMMING

Note: If the unit is **OFF**, first follow the initial start-up instructions at the beginning of the **PROGRAMMING CYCLES** section on page 21.

To access the **MANUAL SHOCK FREEZE** cycle, press  then .

If **0** for **NO** was selected for **SHOCK FREEZE** in **INITIAL PROGRAMMING**, the display will show:

  n .A

(not available)

“1.” indicates the **LOW AIR TEMPERATURE**.

The default setting for the **LOW AIR TEMPERATURE** is **-25 °F**.

 1.  -25

(Flashing)

To change the temperature,

press  or  then press .

This is the minimum air cavity temperature at which the unit operates during the freezing process.

NOTE: There should always be a minimum of seven degrees difference between the low and high air temperature settings.

“2.” indicates the **HIGH AIR TEMPERATURE**.

The default setting for the **HIGH AIR TEMPERATURE** is **-15 °F**.

 2.  -15

(Flashing)

To change the temperature,

press  or  then press .

This is the maximum air cavity temperature at which the unit operates during the freezing process.

“3.” indicates the **CYCLE TIME**.

The default setting for the **CYCLE TIME** is **240 minutes**.

 3.  240

(Flashing)

To change the time,

press  or  then press .

"4." indicates the **HOLD LOW AIR TEMPERATURE**.



(Flashing)

This is the minimum air cavity temperature at which the unit operates during holding mode.

The default setting for the **HOLD LOW AIR TEMPERATURE** is **-4 °F**.

To change the temperature,

press  or  then press .

NOTE: There should always be a minimum of seven degrees difference between the hold low and hold high air temperature settings.

"5." indicates the **HOLD HIGH AIR TEMPERATURE**.



(Flashing)

This is the maximum air cavity temperature at which the unit operates during holding mode.

The default setting for the **HOLD HIGH AIR TEMPERATURE** is **3 °F**.

To change the temperature,

press  or  then press .

The display will show:



Another cycle may be selected to program

at this time, or press  (ON/OFF) to end the **PROGRAMMING CYCLES**.

If no action is taken after one minute, the unit will return to the **OFF** position and the display will show:



8. MANUAL - DEFROST CYCLE PARAMETERS PROGRAMMING

Note: If the unit is **OFF**, first follow the initial start-up instructions at the beginning of the **PROGRAMMING CYCLES** section on page 21.

To access the **MANUAL DEFROST** cycle, press  then .

“1.” indicates the **DEFROST TIME** if Manual Start is used.

1.

15

(Flashing)

The default setting for the **DEFROST TIME** is **15 minutes**.

To change the time,

press  or  then press .

“2.” indicates the **AUTOMATIC DEFROST AVAILABILITY**.

2.

0

(Flashing)

The default setting for the **AUTOMATIC DEFROST AVAILABILITY** is **0** for **NO**.

To change to **1** for **YES**,

press  or  then press .

If **1** for **YES** is selected then:

“3.” indicates the **MINIMUM ACCUMULATED RUN TIME** the unit must operate before the **AUTOMATIC DEFROST CYCLE** will start.

3.

H 06

(Flashing)

The default setting for the **MINIMUM ACCUMULATED RUN TIME** is **SIX HOURS (H 06)**.

To change the time,

press  or  then press .

“4.” indicates the **DURATION** of the automatic defrost cycle.

4.

40

(Flashing)

The default setting for the **DURATION** is **40 minutes**.

To change the time,

press  or  then press .

The display will show:

Another cycle may be selected to program

at this time, or press  (ON/OFF) to end the **PROGRAMMING CYCLES**.



If no action is taken after one minute, the unit will return to the **OFF** position and the display will show:



ELECTRICAL DIAGRAM FOR TK3S-1, TK3-1 AND TK5-1

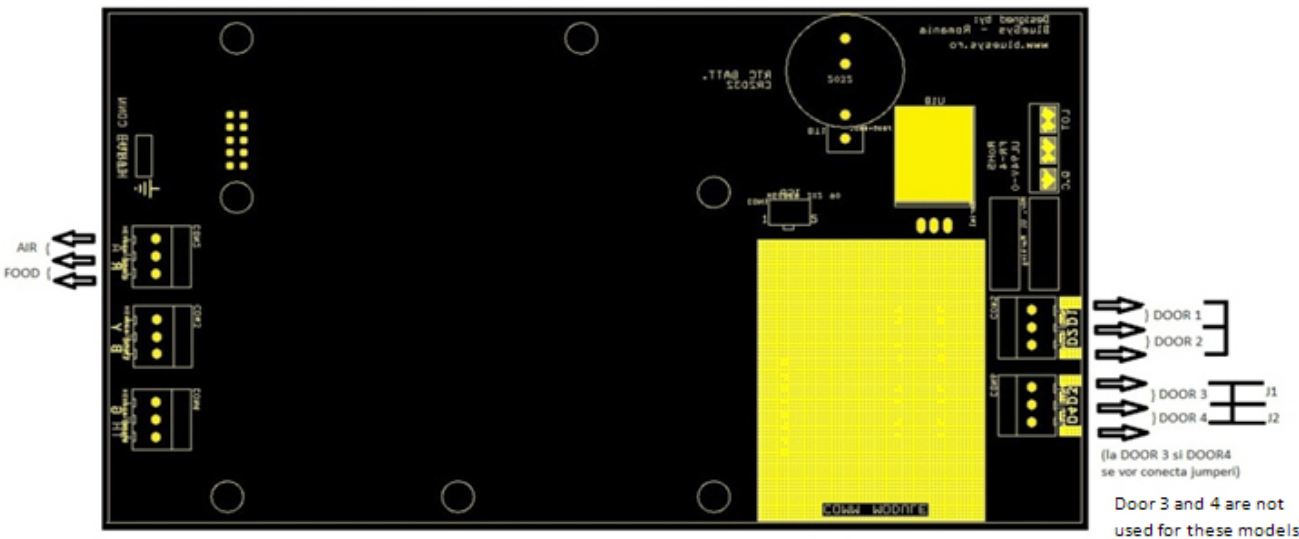
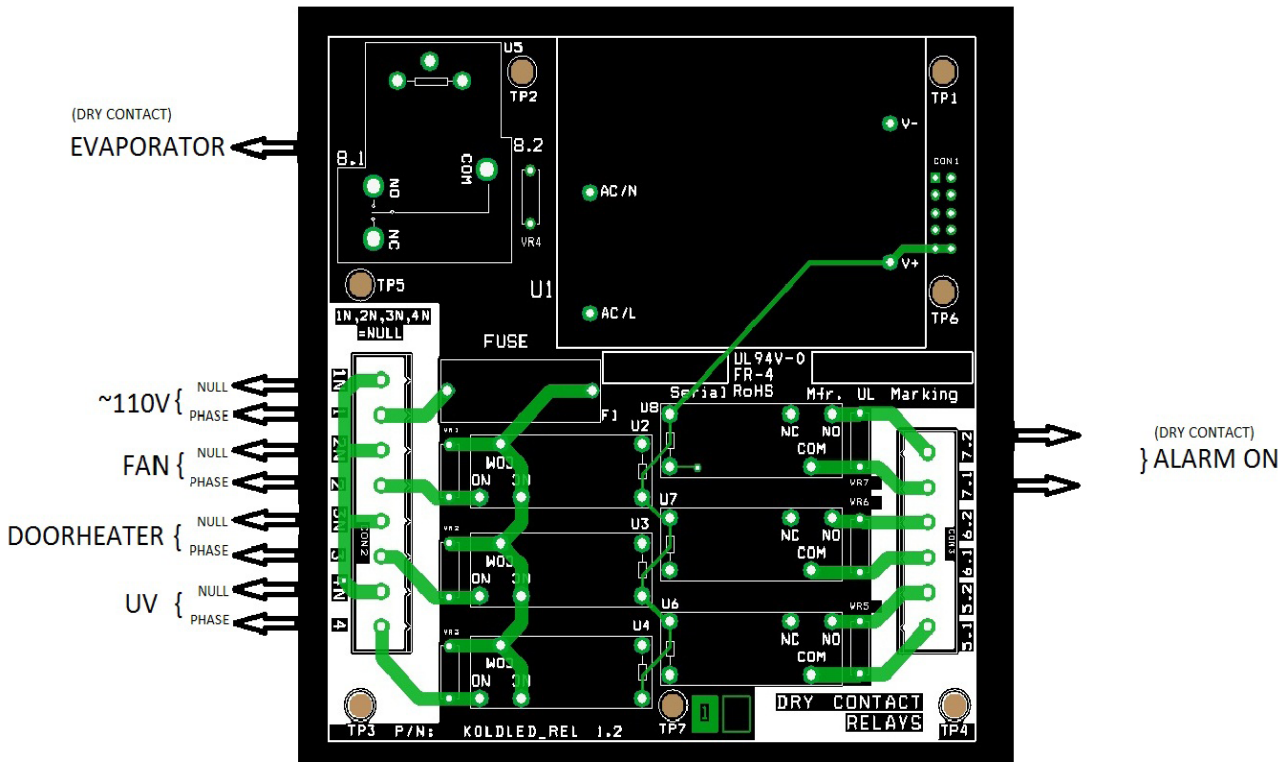

PRINTER (OPTIONAL)

How to Open Lid

Pull the lever until the lid is released from its locked position. To avoid damage, do not use excessive force.

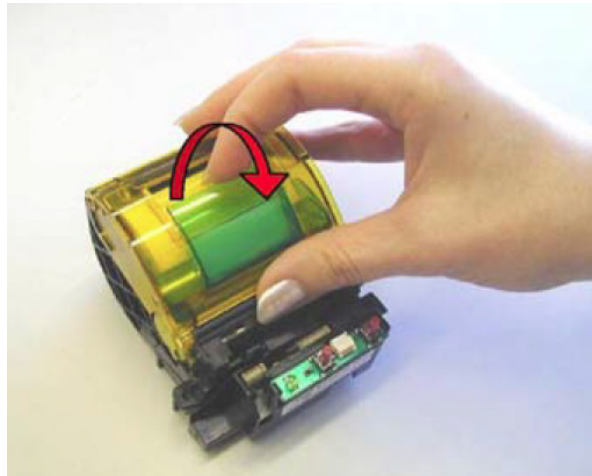

Replacing Paper Roll

If the paper roll needs replacing, open the printer lid and remove the remaining paper. Unspool a few inches from a new roll of paper. Hold approximately two inches of paper outside the device as you place the new roll into the reservoir. Close the lid by applying equal amounts of pressure on each side ensuring the lid is in the locked position. Now tear the spare paper away.

Note: In the case of printer replacement, the red side of the data cable connects to the printer and the black side of the cable connects to the control board.

PC CONNECTION (OPTIONAL)

The two-way full communication between the Blast Chiller and computer is optional and requires an additional software/hardware kit.

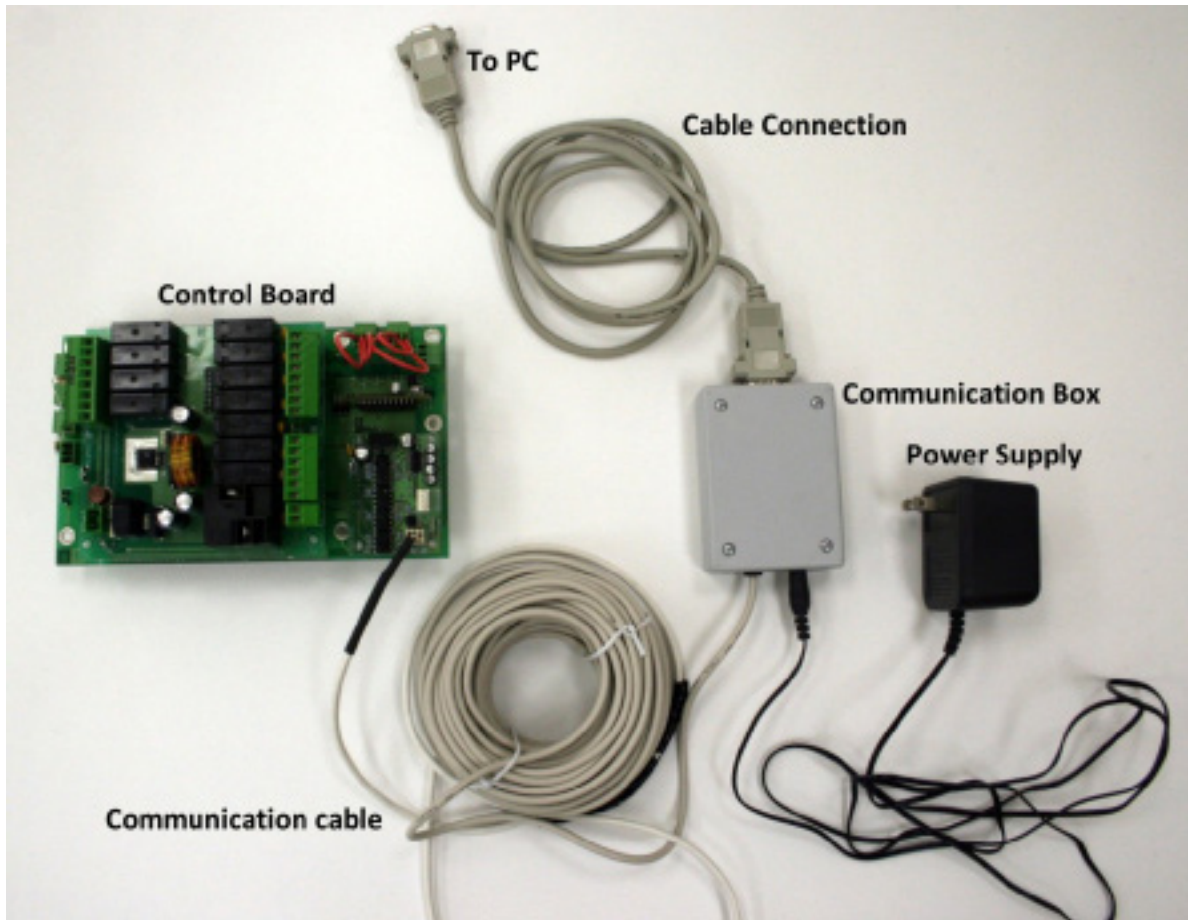

The PC connection kit includes:

1. Communication Box
2. Cable Connection from communication box to the computer serial port
3. Communication Cable from the control board to communication box
4. Power Supply for communication box - 120V, 15A, Plug NEMA 5-15P
5. Software CD

CLEANING INSTRUCTIONS

WARNING: Do not use a pressurized water source such as a hose sprayer to clean the exterior or interior of the unit.

CLEANING THE INTERIOR AND EXTERIOR

The interior cabinet of the blast chiller should be cleaned daily or after each use to avoid altering the taste and aromas of the food.

For cleaning the storage compartment use warm water and mild soap and rinse thoroughly.

Avoid the use of strong detergents and abrasive cleaners as they tend to scratch the surface.

Clean the exterior of the unit with warm water, mild soap and a soft cloth. Dampen the cloth and wipe in the direction of the grain.

Clean the door gaskets to provide a tight seal.

Keep blast chiller probes clean of food products to allow for accurate readings and to avoid any potential food contamination.

If drain lines are in use, keep them clean of condensate water to prevent backups.

Do NOT use cleaners containing chlorine as this may promote corrosion of the stainless steel.

Avoid using sharp tools, especially when cleaning the evaporator.

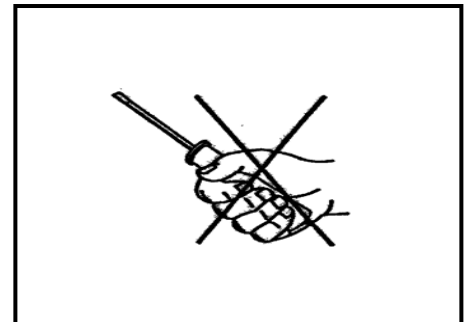
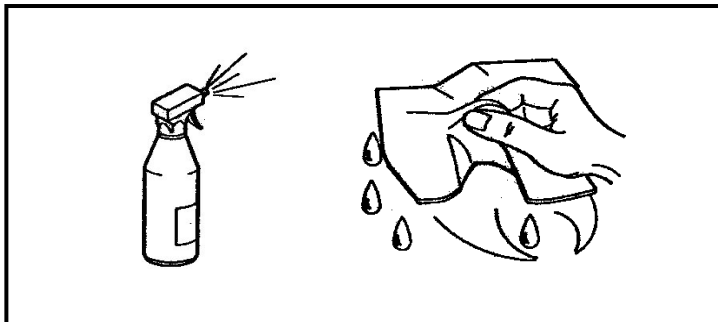

CLEANING THE AIR CONDENSER

Keeping the air condenser clean allows the cabinet to operate more efficiently, allowing the air to circulate freely and use less energy. Cleaning should be scheduled regularly to keep it free from lint and dust accumulation. It is recommended to use a non-metallic brush to remove all the dust and dirt from the condenser fins.

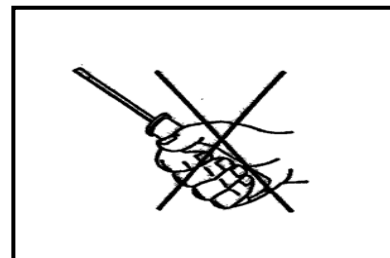
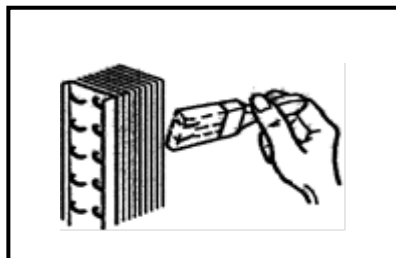

TROUBLESHOOTING GUIDE FOR TK3S-1, TK3-1 AND TK5-1

This section of the manual should be performed by a licensed and certified technician. The electrical diagram can be found on page 38 to reference with instructions below.

The unit will not function or turn on

1. **Disconnect electrical plug from receptacle!** Use a standard screwdriver and take the top cover off the unit.
2. With the top cover off, visually check the top electrical compartment for loose wires and disconnected terminals.
3. Using a volt meter check the main power supply (receptacle) for proper 115VAC \pm 5%.
4. **Reconnect electrical plug to receptacle.** Check the power inside of the unit at the main terminal blocks L1 & L2. The unit must have 115VAC \pm 5%.

Control panel faceplate buttons not working properly

1. Inspect the control panel's faceplate for exterior damage.
2. If there is no exterior damage, use a 5.5mm wrench to adjust the four nuts of the circuit board so that when faceplate buttons are pressed, contact is made with board. A beep will sound when buttons make contact.

The unit does not refrigerate

1. If the compressor, fan condenser and fan evaporator are working, check the refrigerant pressure on the refrigeration system (R404A).
2. If the compressor and fan condenser do not work, start a **MANUAL SHOCK FREEZE** cycle and see if the unit is working. If the compressor and fan condenser start working, the refrigerant level is incorrect.
3. If the compressor and fan condenser still do not work, check the voltage at the termination point on the compressor.
4. If the unit is running and the compressor does not come on and there is 115VAC \pm 5% at the compressor, the compressor is damaged. Consult the factory for replacement parts.

Fan evaporator does not work

1. Start a **MANUAL SHOCK FREEZE** cycle.
2. Check fan voltage, 115VAC \pm 5% at the terminal block.
3. If there is 115VAC for the fan, the fan must be damaged and should be replaced. Consult the factory for replacement parts.
4. If there is not 115VAC for the fan, check the fan relay contacts for 115VAC.
5. If there is 115VAC across the fans relay, check for 24VAC at the coil of the fan relay. If there is not 24VAC across the relay coil, check the circuit board.
6. If there is 24VAC across the relay coil and there is no power 115VAC transferred through the relay contacts to the fan, replace the relay. Consult the factory for replacement parts.

Ice around the door perimeter

1. Start a **MANUAL SHOCK FREEZE** cycle and wait until the air cavity is below 30 °F.
2. Check for 115VAC at the terminal blocks of the door heater.
3. If there is 115VAC for the door heater, the door heater is damaged and should be replaced. Consult the factory for replacement parts.
4. If there is not 115VAC for the door heater, check the relay for the door heater for 115VAC and the circuit board for 24VAC.

Display reads

P r b

n G

1. Check the connections of the **air probe** at the circuit board.
2. The probe is an RTD100 and should read between 100Ω and 110Ω at an ambient of 60 °F to 80 °F. If the probe does not read between these values, replace the air probe. Consult the factory for replacement parts.

Display reads

F b

n G

1. Check the connections of the **food probe** at the circuit board.
2. The probe is an RTD100 and should read between 100Ω and 110Ω at an ambient of 60 °F to 80 °F. If the probe does not read between these values, replace the food probe. Consult the factory for replacement parts.

TROUBLESHOOTING GUIDE FOR TK5-2-C

This section of the manual should be performed by a licensed and certified technician.

The unit will not function or turn on

1. **Disconnect electrical plug from receptacle!** Use a standard screwdriver and take the top cover off the unit.
2. With the top cover off, visually check the top electrical compartment for loose wires and disconnected terminals.
3. Using a volt meter check the main power supply (receptacle) for proper 208VAC \pm 5%.
4. **Reconnect electrical plug to receptacle.** Check the power inside of the unit at the main terminal blocks L1 & L2. The unit must have 208VAC \pm 5%.

Control panel faceplate buttons not working properly

1. Inspect the control panel's faceplate for exterior damage.
2. If there is no exterior damage, use a 5.5mm wrench to adjust the four nuts of the circuit board so that when faceplate buttons are pressed, contact is made with board. A beep will sound when buttons make contact.

The unit does not refrigerate

1. If the compressor, fan condenser and fan evaporator are working, check the refrigerant pressure on the refrigeration system (R404A).
2. If the compressor and fan condenser do not work, start a **MANUAL SHOCK FREEZE** cycle and see if the unit is working. If the compressor and fan condenser start working, the refrigerant level is incorrect.
3. If the compressor and fan condenser still do not work, check the voltage at the termination point on the compressor.
4. If the unit is running and the compressor does not come on and there is 208VAC \pm 5% at the compressor, the compressor is damaged. Consult the factory for replacement parts.

Fan evaporator does not work

1. Start a **MANUAL SHOCK FREEZE** cycle.
2. Check fan voltage, 208VAC \pm 5% at the terminal block.
3. If there is 208VAC for the fan, the fan must be damaged and should be replaced. Consult the factory for replacement parts.
4. If there is not 208VAC for the fan, check the fan relay contacts for 208VAC.
5. If there is 208VAC across the fans relay, check for 24VAC at the coil of the fan relay. If there is not 24VAC across the relay coil, check the circuit board.
6. If there is 24VAC across the relay coil and there is no power 208VAC transferred through the relay contacts to the fan, replace the relay. Consult the factory for replacement parts.

Ice around the door perimeter

1. Start a **MANUAL SHOCK FREEZE** cycle and wait until the air cavity is below 30 °F.
2. Check for 208VAC at the terminal blocks of the door heater.
3. If there is 208VAC for the door heater, the door heater is damaged and should be replaced. Consult the factory for replacement parts.
4. If there is not 208VAC for the door heater, check the relay for the door heater for 208VAC and the circuit board for 24VAC.

Display reads

P r b

n G

1. Check the connections of the **air probe** at the circuit board.
2. The probe is an RTD100 and should read between 100Ω and 110Ω at an ambient of 60 °F to 80 °F. If the probe does not read between these values, replace the air probe. Consult the factory for replacement parts.

Display reads

F b

n G

1. Check the connections of the **food probe** at the circuit board.
2. The probe is an RTD100 and should read between 100Ω and 110Ω at an ambient of 60 °F to 80 °F. If the probe does not read between these values, replace the food probe. Consult the factory for replacement parts.

WARRANTY

The warranty covers all parts, with the exception of the printer and the food probes, found to be defective as well as the labor required to replace them for a period of one year from the date of shipment.

For full warranty details please refer to the **Thermo-Kool®** standard warranty supplied with each unit or available upon request.

